

· dove · l'acqua · ha · origine ·



· at · the · origin · of · water ·
· où · l'eau · a · son · origin ·

mina

Natural, balanced, on time.

The character of IVI perfectly expresses the nature of the tap, focusing on the water supply without further additions, and is a classic in the expressive language of contemporary design.

The unique choice of **stainless steel** and the **attention to details** make the difference. As always in MINA.

Naturel, équilibré, ponctuel.

Le caractère d'IVI exprime parfaitement la nature du robinet, en se concentrant et c'est un classique dans le langage expressif du design contemporain.

Le choix unique de l'**acier inoxydable** et l'**attention aux détails** font la différence. Comme toujours dans MINA.

Naturale, bilanciato, puntuale.

Il carattere di IVI esprime perfettamente la natura del rubinetto, concentrandosi sull'erogazione dell'acqua senza ulteriori aggiunte, ed è un classico nel linguaggio espressivo del design contemporaneo.

Sono la scelta univoca dell'**acciaio inox** e la **cura dei dettagli** a fare la differenza. Come sempre in MINA.



ivi | 8251 S



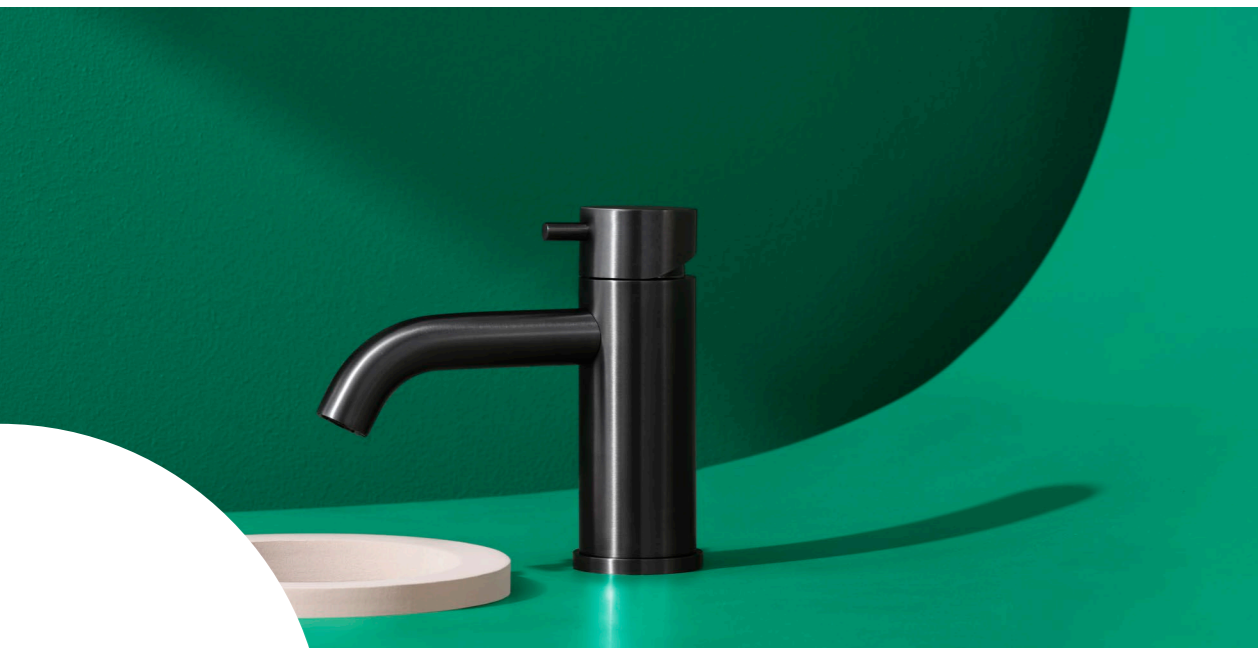

ivi | 8251 DG

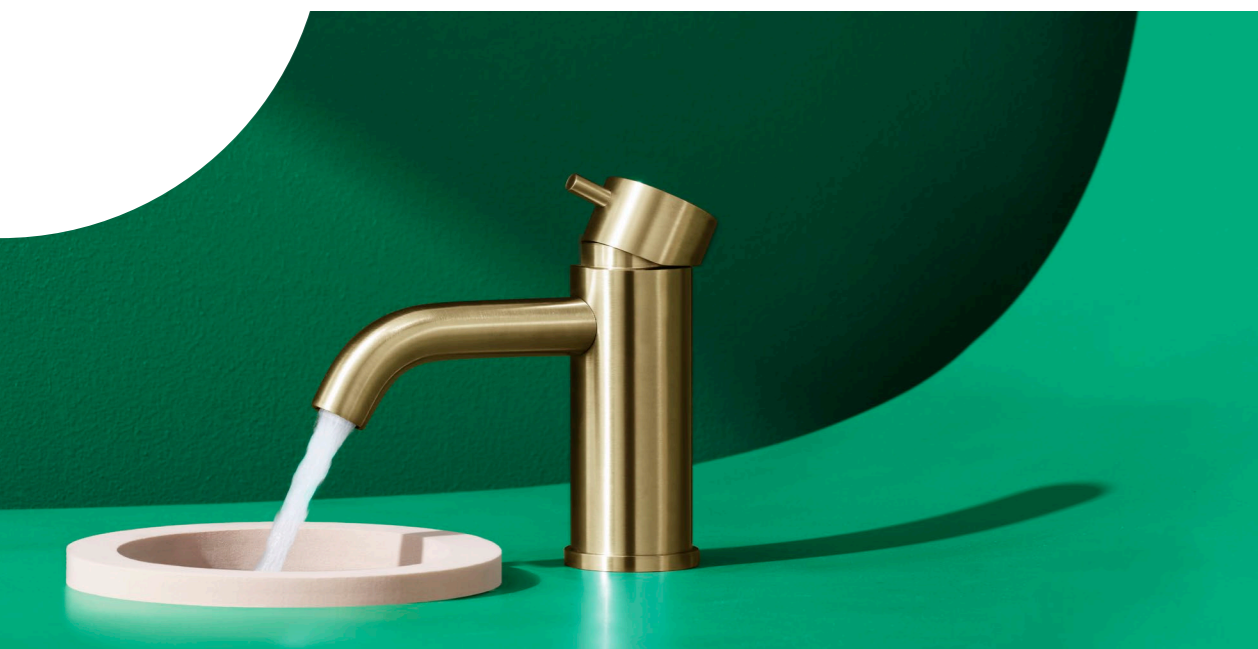

ivi | 8251 K

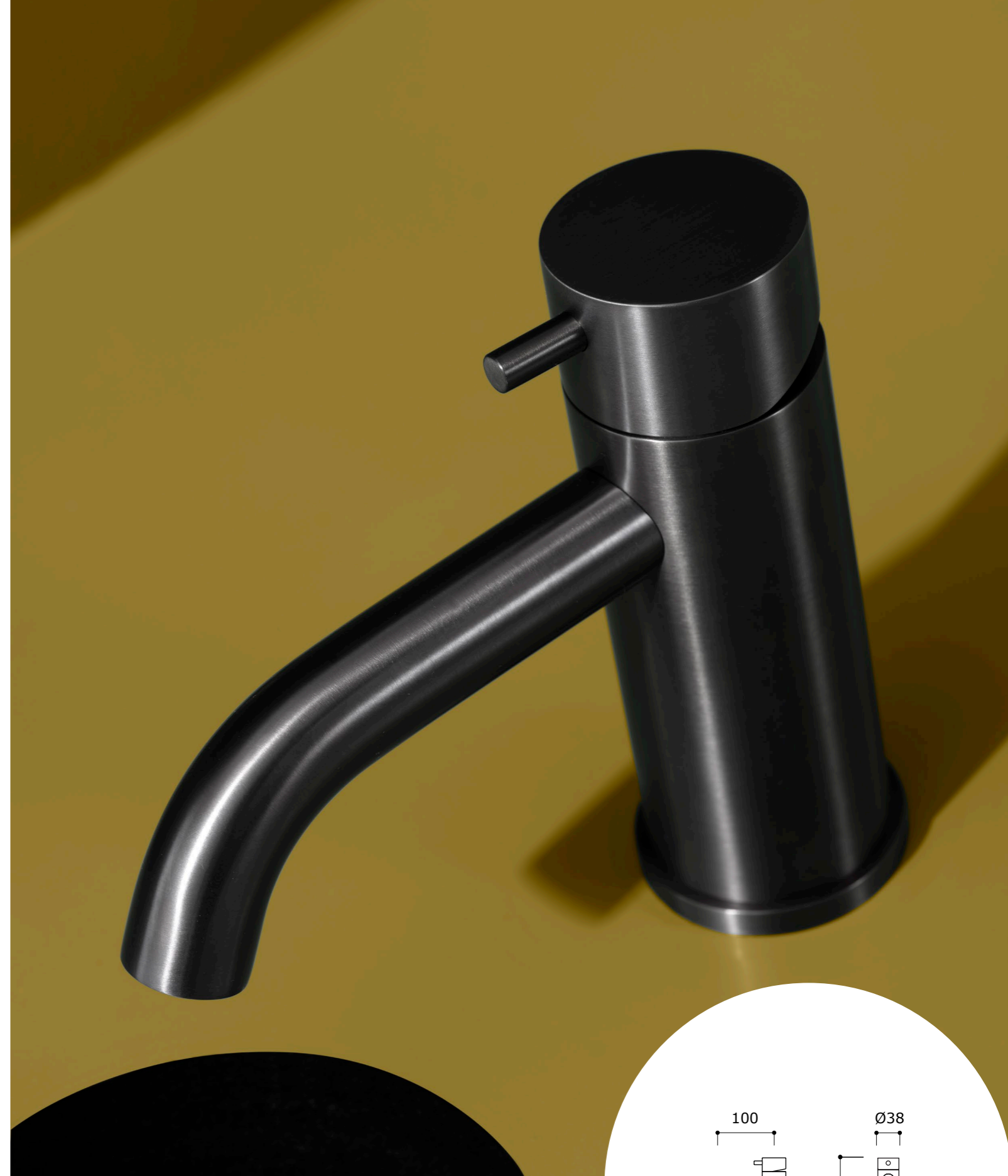

ivi | 8251 DG

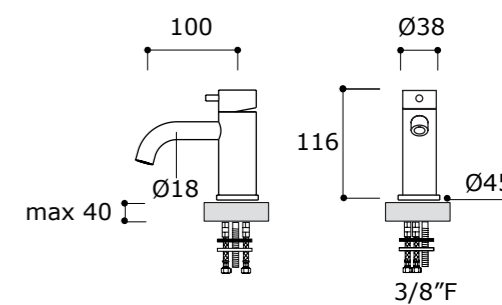

IVI is a versatile and **customizable faucet suitable for the customer.**

A collection listening, here "in the same space" of the project, able to interpret trends and to fit with class in any bathroom environment.

IVI est une robinetterie polyvalente et **personnalisable à la mesure du client.**

Une collection à l'écoute, ici "dans le même espace" du projet, capable de interpréter les tendances et de s'insérer avec classe dans chaque salle de bains.

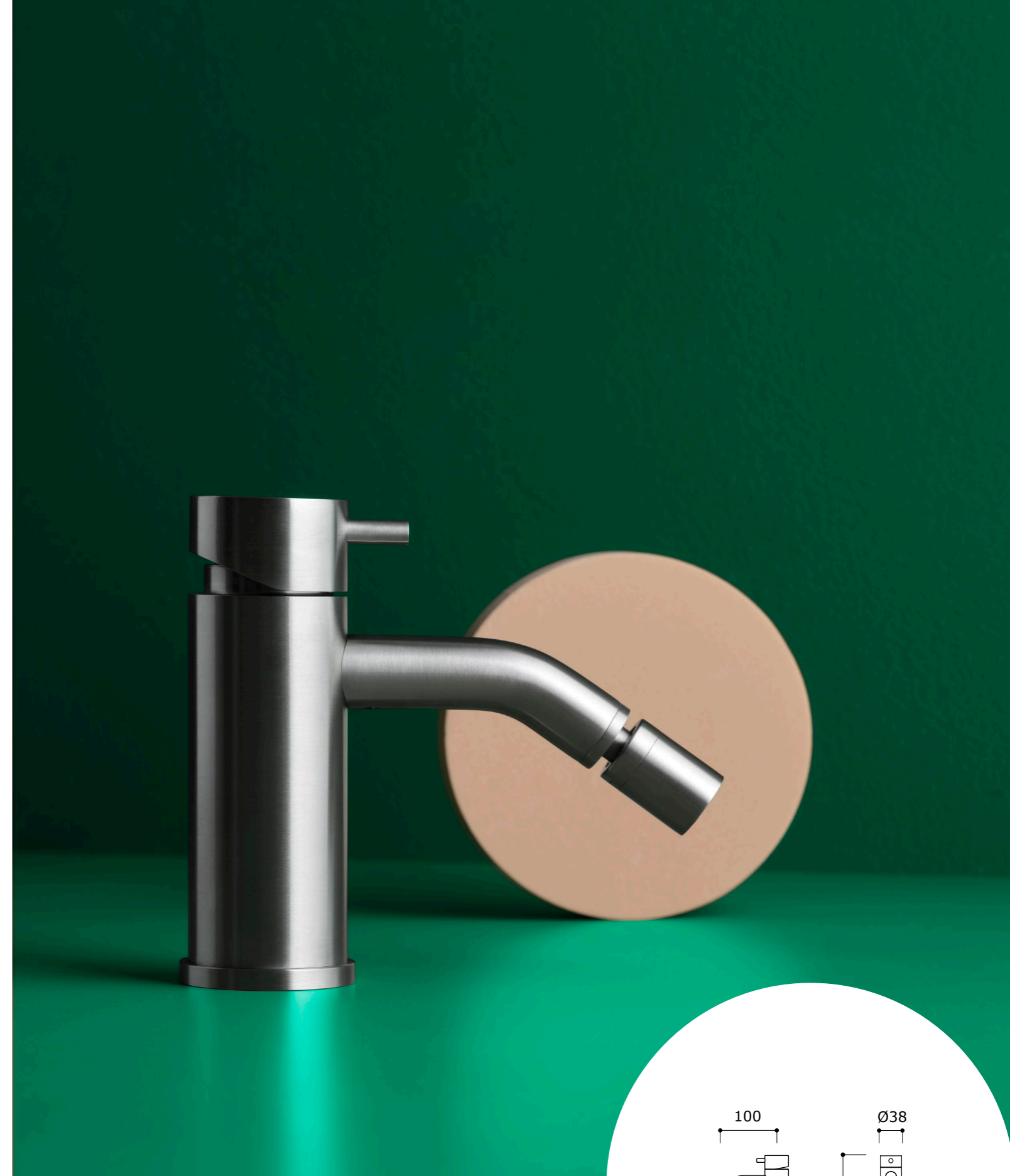

ivi | 8253 S

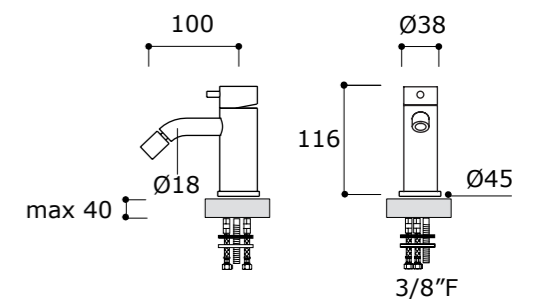

IVI è una rubinetteria versatile e **personalizzabile a misura del cliente.**

Una collezione in ascolto, qui "nello stesso spazio" del progetto, capace di interpretare le tendenze e di inserirsi con classe in ogni ambiente bagno.

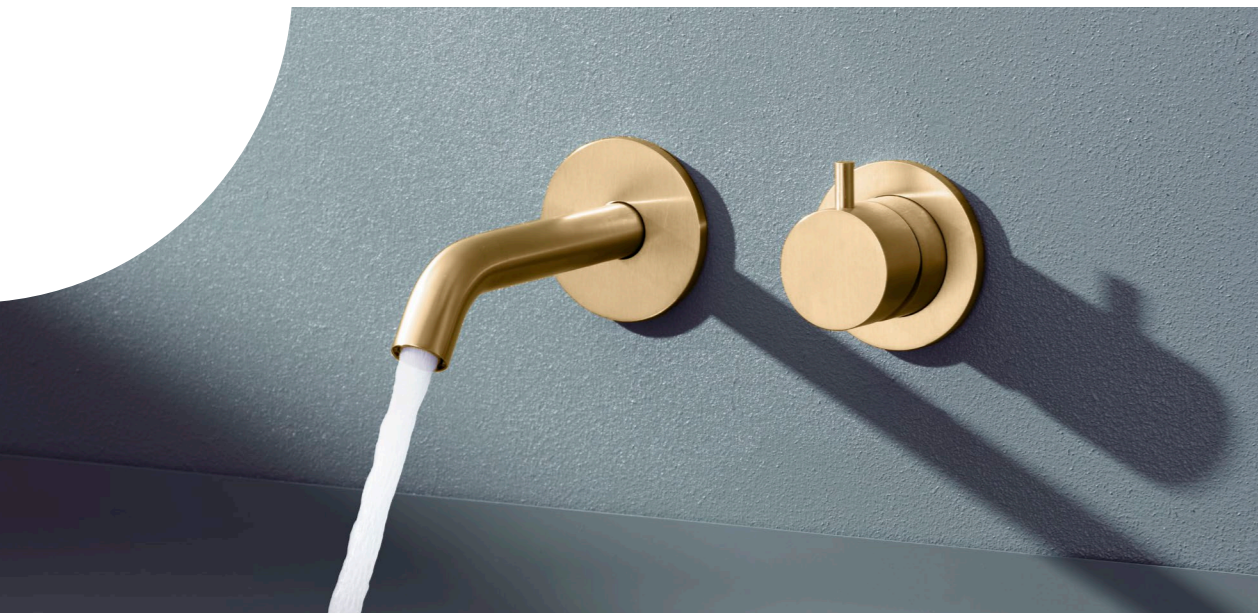

ivi | 81816 K



ivi | 81816 DG

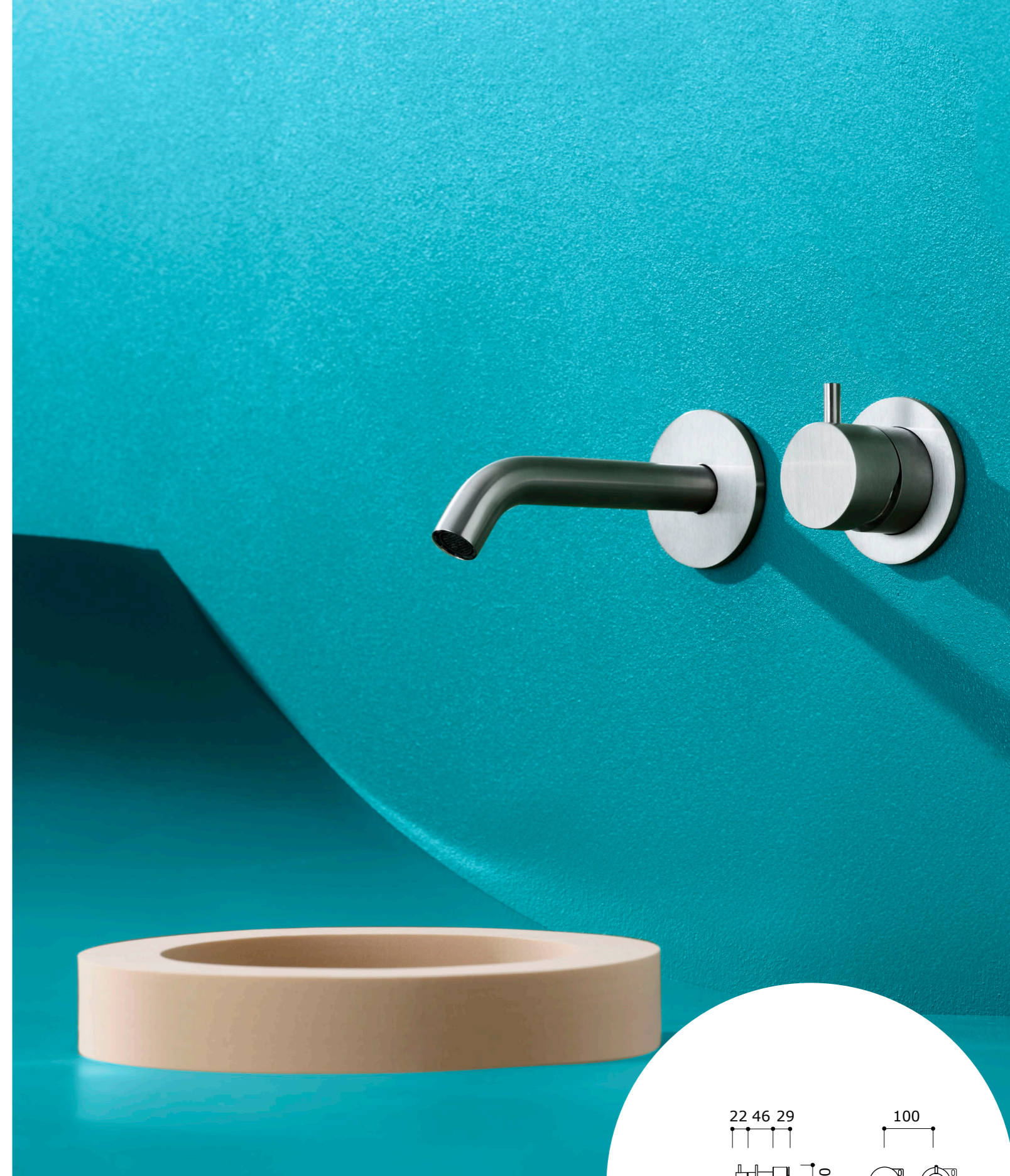

ivi | 81816 S

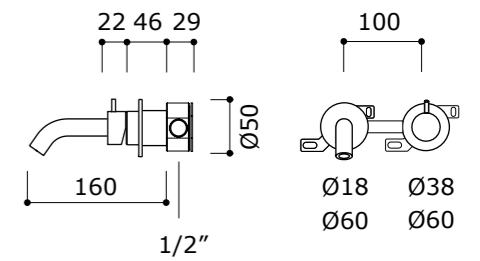

The IVI collection is made entirely of **AISI 316 L** stainless steel. Including recessed parts, accessories, and accessories.

In addition to the classic solution in **Brushed Steel**, where a meticulous brushing is performed piece by piece directly in MINA, the finishes are available **Deep Grey** and **Velvet Gold**.

A deep gray for those who prefer dark taps and a saturated and precious gold, obtained galvanically with 24K gold.

La collezione IVI est entièrement réalisée en acier inox **AISI 316 L**. Y compris les pièces encastrées, tous les accessoires et compléments.

En plus de la solution classique en acier brossé, où un brossage artisanal méticuleux est effectué pièce par pièce directement en MINA, les finitions **Deep Grey** et **Velvet Gold** sont disponibles.

Un gris profond pour ceux qui préfèrent les robinetteries sombres et un or saturé et précieux, obtenu galvaniquement avec de l'or 24K.



La collezione IVI è realizzata interamente in acciaio inox **AISI 316 L**. Compresa le parti ad incasso, tutti gli accessori e i complementi.

Oltre alla classica soluzione in **Acciaio Spazzolato**, dove una meticolosa spazzolatura artigianale viene eseguita pezzo a pezzo direttamente in MINA, sono disponibili le finiture **Deep Grey** e **Velvet Gold**.

Un grigio profondo per chi predilige le rubinetterie scure e un oro saturo e prezioso, ottenuto galvanicamente con oro 24K.

ivi | 8900_0825_0700_G50 S

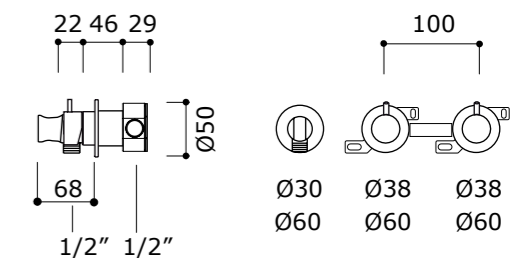



ivi | 0700_G50 S

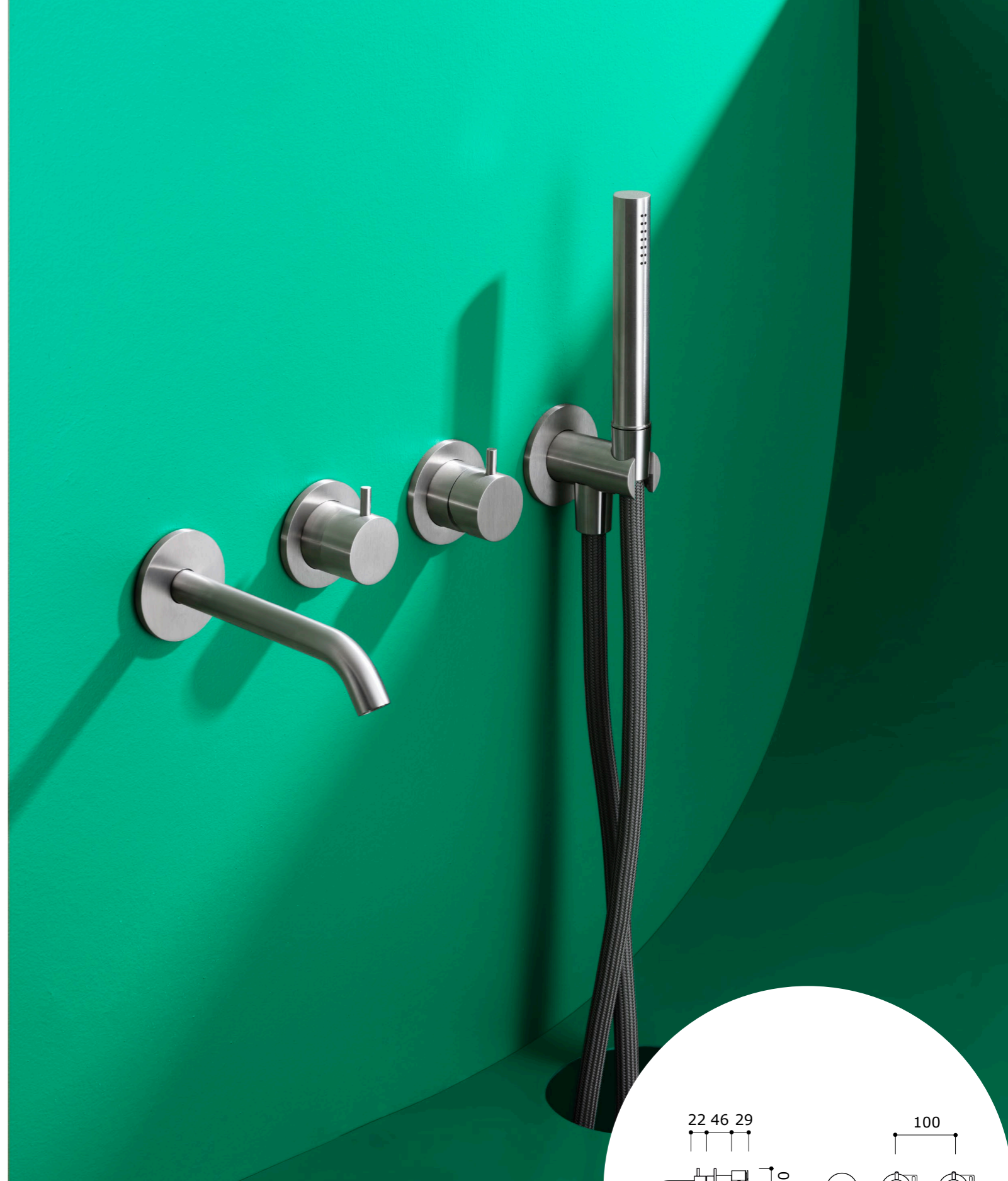

ivi | 8016_8900_0825_0700_G50 S

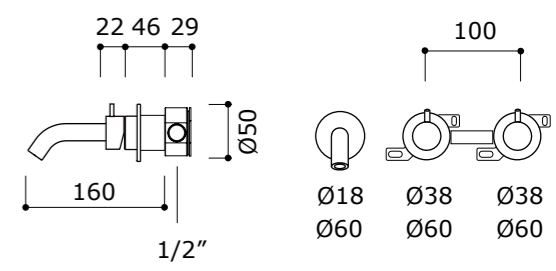

ivi
TECHNICAL



Elenco articoli della collezione IVI disponibili su MINA /PRICE LIST
List of articles by IVI collection available on MINA /PRICE LIST
Liste des articles de la collection IVI disponible sur MINA /LISTE DE PRIX

BOCCHIE DI EROGAZIONE DA PARETE
WALL MOUNTED SPOUTS
BECS A MUR



8016

GRUPPO MISCELATORE INCASSO
CONCEALED WALL MOUNTED MIXER
GROUPE MITIGEUR A MUR

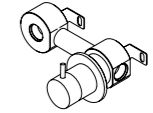

8182

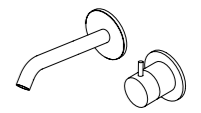

81816

MISCELATORI DA APPOGGIO
DECK MOUNTED MIXERS
MITIGEURS SUR GORGE



8251

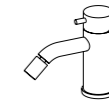

8253

MISCELATORI/ DEVIATORI DA INCASSO
WALL MOUNTED MIXERS / DIVERTERS
MITIGEURS / INVERSEURS A MUR



8100

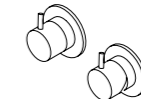

8900

GRUPPI VASCA INCASSO
WALL MOUNTED BATH SET
GROUPE BAIGNOIRE A MUR

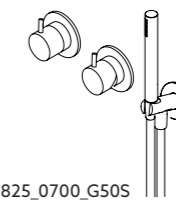

8900_0825_0700_G50S

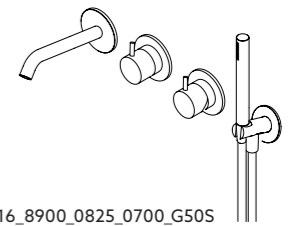

8016_8900_0825_0700_G50S

SOFFIONI DOCCIA
SHOWER HEAD
POMME DE DOUCHE

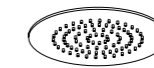

080250

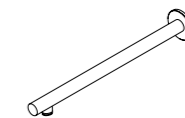

008350

DOCCETTE E ACCESSORI
HAND SHOWERS AND COMPLEMENTS
DOUCHETTE ET COMPLEMENTS



0700_G50S

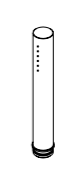

0700



0500



0825

L'azienda si riserva in qualunque momento di apportare modifiche a prodotti e accessori. I dati riportati in questo documento hanno carattere informativo e non sono vincolanti.

The manufacturer reserves the right to modify products and accessories at any time. Dates, products and sketches included in this document are just for information and do not bind the producer.

Les données fournies dans le present document sont seulement d'information et ne sont pas contraignant. La société se réserve le droite d'apporter des modifications aux produits et accesories en tout le temps.

AZIENDA CON SISTEMA DI GESTIONE QUALITÀ CERTIFICATO. ISO 9001:2015
COMPANY WITH QUALITY MANAGEMENT SYSTEM CERTIFIED TO ISO 9001:2015
ENTREPRISE AVEC UN SYSTÈME DE GESTION DE LA QUALITÉ CERTIFIÉ ISO 9001:2015

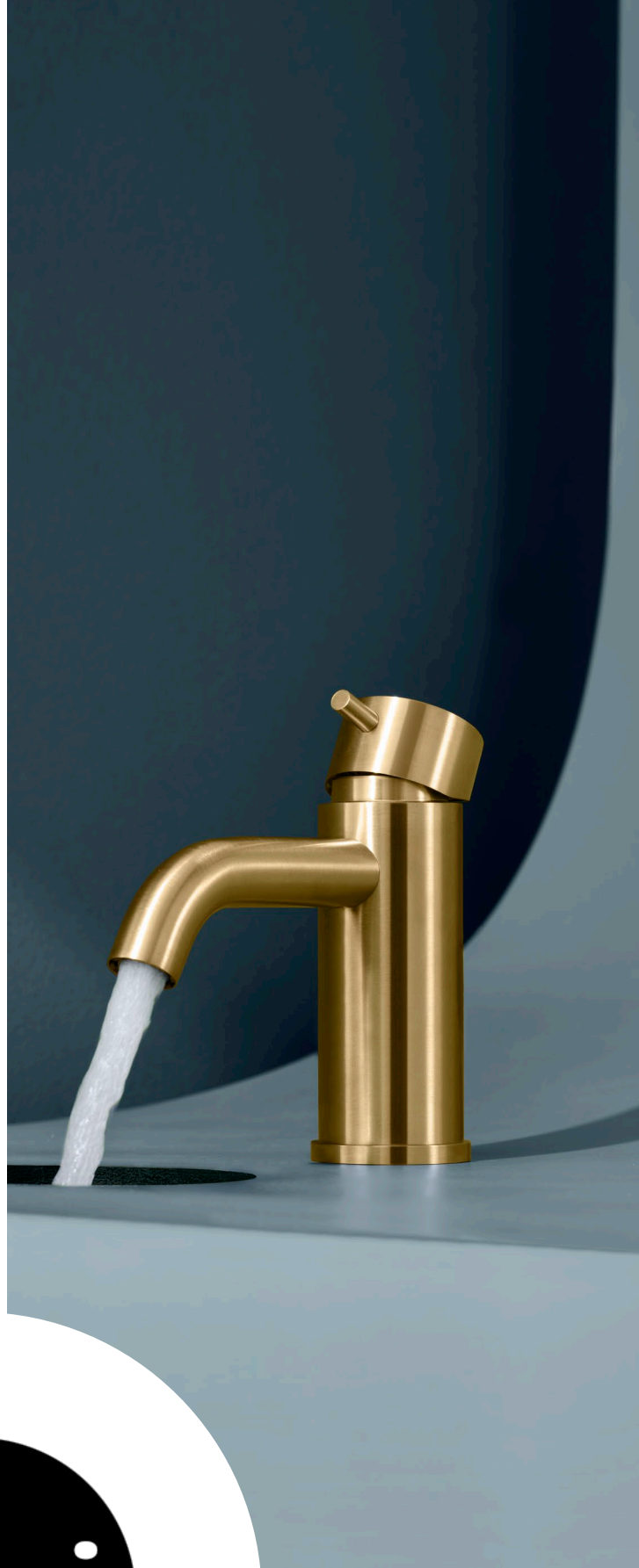

IVI MINA #inox

Art Direction e Styling: Zu.Ba.Lu.

Photography : Neroluce

Graphic: Zu.Ba.Lu.



Mina s.r.l.

Via Zignone 26
13017 Quarona (VC) Italy
Tel. +39 0163 432410 /
432756

www.minainox.com