

mina

B

BATHROOM CATALOGUE

M I N A # I N O X

100% STAINLESS STEEL

CATALOGUE BAIN

M I N A # I N O X

100% ACIER INOXYDABLE

CATALOGO BAGNO

M I N A # I N O X

100% ACCIAIO INOSSIDABILE

3 | MINA#inox

7 | Corsivo

29 | Synth

47 | Stiriana

63 | Dimensione 74

75 | Revitrum

83 | Giotto

93 | Must

97 | SHOWER

111 | FITTINGS and COMPLEMENTS



Bathroom



COMPANY

Mina, una storia di passione e di acciaio inox.

MINA è un'azienda familiare capace di unire con innata genuinità l'esperienza artigianale con il gusto per il progetto, la qualità industriale certificata e il legame con la materia prima.

Attiva sin dai primi anni 50, nel 1998 la scelta univoca di produrre rubinetteria esclusivamente in acciaio inossidabile.

L'AISI316L è tutt'oggi l'asse portante dello sviluppo aziendale: per MINA la materia migliore per proporre collezioni di rubinetteria di alta gamma destinate alla cucina e al bagno, spaziando tra complementi e accessori tutti rigorosamente realizzati in acciaio inox.

Eccellenza e passione artigianale si coniugano con la vocazione a seguire personalmente e con attenzione ogni cliente. Per creare progetti su misura, che nascono dal dialogo diretto con l'azienda e riescono a soddisfare sempre le aspettative.

A story of passion and stainless steel.

MINA is a family business able to connect with innate genuinity the artisan experience with the taste for the project, the quality industrial certified and the link with the raw material.

Active since the early 50's, in 1998 the unique choice to produce taps and fittings made exclusively of stainless steel.

The AISI316L is still today the backbone of the company's development: for MINA the best material to propose collections of taps and fittings of high range intended for the kitchen and bathroom, ranging between complements and accessories all strictly made of stainless steel.

Excellence and passion for craftsmanship are combined with a vocation to personally and carefully follow each customer. To create custom-made projects, which are the result of direct dialogue with the company, and are always able to meet expectations.

Une histoire de passion et d'acier inoxydable.

MINA est une entreprise familiale capable de conjuguer l'authenticité innée à l'expérience artisanale avec le goût pour le projet, la qualité certifiée industrielle et la relation avec la matière première.

Actif depuis le début des années 50, en 1998 le choix unique de produire robinets et robinetterie exclusivement en acier inoxydable.

L'AISI316L est encore aujourd'hui la colonne plus importante du développement de l'entreprise : pour MINA le meilleur matériel pour proposer des collections de robinetteries de gamme haut destinée à la cuisine et à la salle de bains, qui va de la compléments et accessoires tous strictement en acier inoxydable.

L'excellence et la passion de l'artisanat se conjuguent à la vocation de suivre personnellement et attentivement chaque client.

Pour créer des projets sur mesure, issus d'un dialogue direct avec l'entreprise, et sont toujours en mesure de répondre aux attentes.

MINA progetta intorno all'acqua.
Rubinetteria da bagno e da cucina, ambienti domestici o prestigiosi contract, ma anche soluzioni passepartout che trovano spazio in contesti wellness o in progetti outdoor.

MINA designs around water.
Bathroom and kitchen taps, domestic spaces or prestigious contracts, but also passepartout solutions that find space in wellness contexts or in outdoor projects.

MINA dessine autour de l'eau.
Robinetterie de salle de bains et de cuisine, espaces intérieurs ou contrats prestigieux, mais aussi des solutions passepartout qui trouvent leur place dans des contextes de wellness ou dans des projets de plein air.

MINA è esperienza, voglia di sperimentare e capacità di seguire il progetto in ogni aspetto evolutivo. L'idea nasce in MINA, qui viene sviluppata, analizzata e realizzata seguendo tutte le fasi di produzione.
Rigorosamente Made in Italy: made in MINA.

MINA is experience, determination to experiment and ability to follow the project in every evolutionary aspect. The idea was born in MINA, here it is elaborated, analyzed and realized following all the production phases.
Strictly Made in Italy: made in MINA.

MINA, c'est l'expérience, la volonté d'expérimenter et la capacité de suivre le projet dans tous ses aspects évolutifs. L'idée est née à MINA, ici elle est élaborée, analysée et réalisée en suivant toutes les phases de production.
Strictelement Made in Italy : made in MINA.

Ascolto, contatto diretto con il cliente, soluzioni personalizzate, flessibilità produttiva, servizio post vendita.
Un servizio speciale firmato MINA, dedicato interamente a chi progetta.

Ability to listen, direct contact with the customer, customised solutions, production flexibility, after-sales service.
A special service signed MINA, completely dedicated to the designer.

Ecoute, contact direct avec le client, solutions personnalisées, flexibilité de production, service après-vente.
Un service spécial signé MINA, entièrement dédié à ceux qui dessinent.



INOX perchè è resistente alla corrosione.
INOX perchè è igienico e sicuro.
INOX perchè è riciclabile al 100%.
MINA è INOX, ma non solo per le parti estetiche, lavorate per esaltare la superficie dell'acciaio.
In MINA ogni pezzo, anche se destinato ad essere nascosto all'interno della parete, è ricavato integralmente da una barra di acciaio inossidabile AISI316L, per garantire nel tempo un valore di alto livello di utilizzo e di integrità delle proprietà.
La scelta di un materiale di pregio, inalterabile e sano per quelle parti del miscelatore che andranno incassate a muro è una scelta di campo che condiziona, in maniera silenziosa e invisibile, le prestazioni di un miscelatore da incasso.
E' la scelta di MINA.

INOX because it is resistant to corrosion.
INOX because it is hygienic and safe.
INOX because it is 100% recyclable.
MINA is INOX, but not only for the aesthetic parts, worked for to enhance the surface of the steel.
In MINA every piece, even if it is intended to be hidden inside the wall, is fully obtained from a bar of AISI316L stainless steel, to guarantee over time a value of high level of use and integrity o properties.
The choice of a high quality material, unchanged and healthy for those parts of the mixer that will be built-in to the wall is a choice of field that conditions, in a silent and invisible way, the performance of a built-in mixer.
It's the choice of MINA.

INOX pour sa résistance à la corrosion.
INOX parce qu'il est hygiénique et sans risque.
INOX parce qu'il est recyclable à 100%.
MINA est INOX, mais pas seulement pour les parties esthétiques, travaillées pour pour valoriser la surface de l'acier.
En MINA, chaque pièce, même si elle est destinée à être cachée, à l'intérieur du mur, est entièrement sculptée à partir d'une barre de acier inoxydable AISI316L, pour garantir dans le temps une valeur de niveau élevé d'utilisation et d'intégrité des propriétés.
Le choix d'un matériau précieux, inaltérable et sain pour ceux qui le désirent des parties du mélangeur qui seront encastrées dans le mur est un choix de qui conditionne, de façon silencieuse et invisible, le processus de la d'un mélangeur à mur.
C'est le choix de MINA.

BAGNO+CUCINA
BATHROOM+KITCHEN
BAIN+CUISINE

MADE IN ITALY

SU MISURA
CUSTOM MADE
SUR MESURE

AISI316L

B+K

IT

CM

INOX



Shower



OLIVIA 0801T

Le collezioni MINA, ed in particolare le soluzioni Shower, sono pensate non solo per ambienti domestici, ma anche per spazi outdoor e contesti wellness.

L'acciaio inox resiste perfettamente sia agli agenti esterni che a condizioni sfavorevoli quali zone marine o acque termali.



**SYNT
40801T**



**STIRIANA
60802500T**



**CORSIVO
11802711T**

The MINA collections, and in particular the Shower solutions, are designed not only for domestic spaces, but also for outdoor spaces and wellness contexts.

Stainless steel is perfectly resistant both to external agents and to unfavourable conditions such as sea areas or thermal waters.



SYNTH 40802700WT

Les collections MINA, et en particulier les solutions Douche, sont pour les espaces domestiques, mais aussi pour les espaces extérieurs et le wellness.

L'acier inoxydable résiste parfaitement aux agents extérieurs et aux conditions adverses comme la mer ou les eaux thermales.



POT FILLER 96111



WARA 19480

S



FINE
35300 | FV400



LAMA 06137



VELA 08403



CORSIVO 11TH22



KAI 0200
55100

Kai è la nuova doccia di MINA con getto Kneipp. Si può inserire in ogni composizione doccia, ma si abbina perfettamente alla colonna doppio termostatico esterna, dove si gestisce con un mix termostatico interamente dedicato.

Kai is the new MINA hand shower with Kneipp jet. It can be inserted in each shower composition, but it perfectly combines with the column external double thermostatic, where it can be managed with a thermostatic mix entirely dedicated.

Kai est la nouvelle douchette MINA avec jet Kneipp. Il peut être inséré dans chaque composition de douche, mais elle s'harmonise parfaitement avec la colonne double thermostatique externe, où il peut être contrôlé avec un mix thermostatique entièrement dédié.

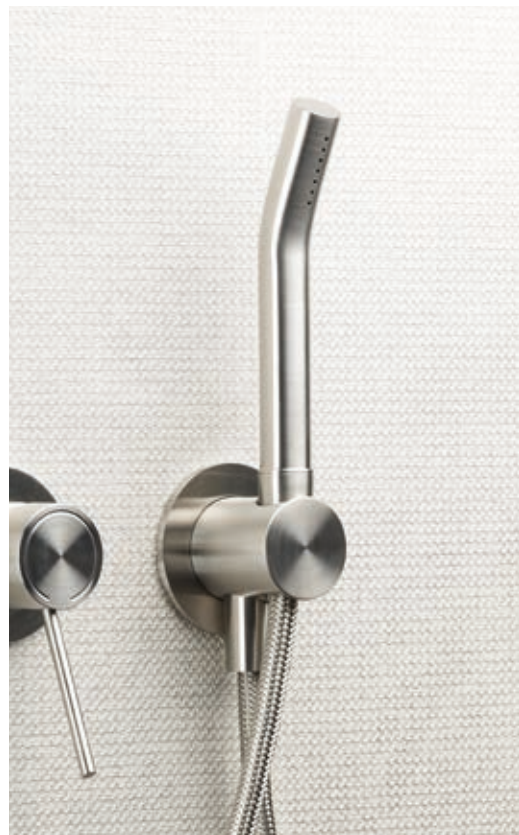

CORSIVO 01142 | 0711

SHOWER 444



TECHNICAL

Shower

Elenco articoli Shower
 disponibili su MINA /PRICE LIST
 Articles list Shower
 available on MINA /PRICE LIST
 Liste des articles Shower
 disponible sur MINA /LISTE DE PRIX

COLONNE DOCCIA
 STANDING FLOOR SHOWERS
 COLONNES DOUCHE

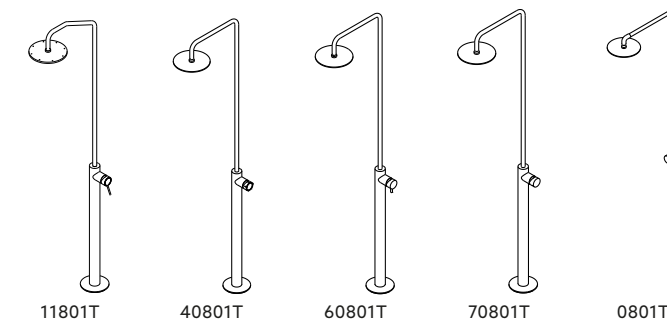

11801T 40801T 60801T 70801T 0801T

COLONNE DOCCIA CON DOCCETTA
 STANDING FLOOR SHOWERS WITH HAND SHOWER
 COLONNES DOUCHE AVEC DOUCHETTE

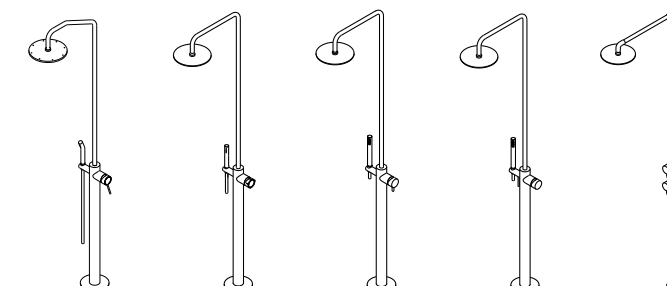

11802711T 40802700XT 60802500T 70802500XT 0802T

ESTERNO DOCCIA MISCELATORE / TERMOSTATICO
 EXTERNAL SHOWER MIXER / THERMOSTATIC
 DOUCHE EXTERNE MITIGEUR / THERMOSTATIQUE

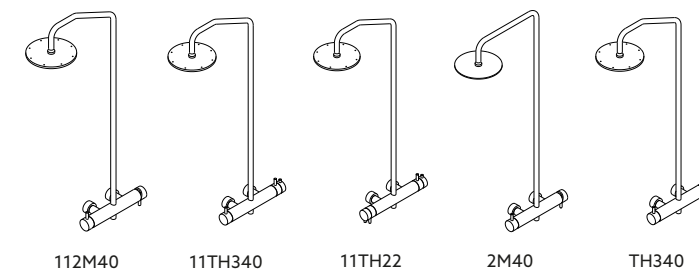

112M40 11TH340 11TH22 2M40 TH340

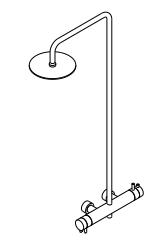

TH22

KAI / DOCCETTA CON GETTO KNEIPP
 KAI / HAND SHOWER WITH KNEIPP JET
 KAI / DOUCHETTE AVEC JET KNEIPP



0200 55100

SOFFIONI DOCCIA A PARETE
WALL MOUNTED SHOWER HEADS
POMMES DE DOUCHE MURALS

LAMA

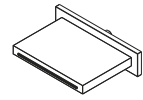

06086

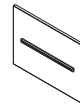

06137

WARA

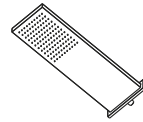

18450

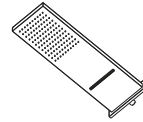

18460

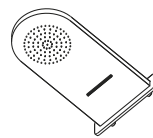

19380

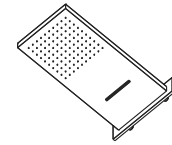

19480

SOFFIONI DOCCIA DA INCASSO
CEILING MOUNTED SHOWER HEADS
POMMES DE DOUCHE A PLAFOND

VELA

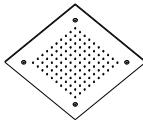

08171

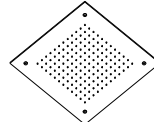

08446

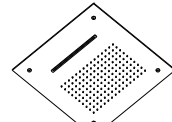

08216

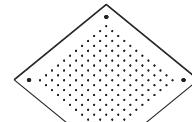

08402

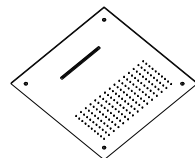

08403

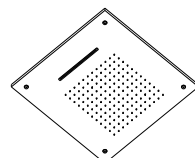

09345

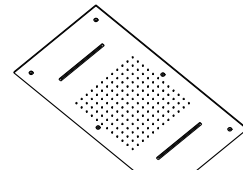

079110

SOFFIONI DOCCIA E BRACCI
SHOWER HEADS AND SHOWER ARMS
POMMES DE DOUCHE ET BRAS



35200

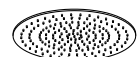

35300



35400



35VR1



35VR2



FV400

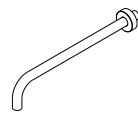

F350

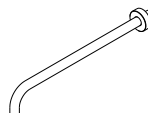

F400

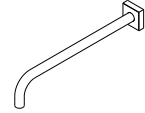

F350Q

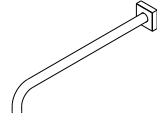

F400Q

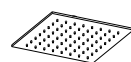

45200

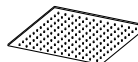

45300

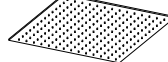

45400



45VR1



45VR2



FV400Q

DOCCETTE E ACCESSORI
HAND SHOWERS AND COMPLEMENTS
DOUCHETTES ET COMPLEMENTS



0711



0700



0500

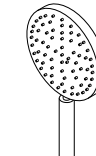

0600

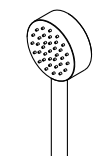

0242



0400



01142



0421



042



043



044



045



0426



04642



02224



0143



0150



55100



55711



55444



55500

SALISCENDI/BODY JETS
SHOWER SLIDE BARS / BODY JETS
BARRE COULIDOUCHE / BODY JETS



0419



444

L'azienda si riserva in qualunque momento di apportare modifiche a prodotti e accessori. I dati riportati in questo documento hanno carattere informativo e non sono vincolanti.

The manufacturer reserves the right to modify products and accessories at any time. Dates, products and sketches included in this document are just for information and do not bind the producer.

Les données fournies dans le present document sont seulement d'information et ne sont pas contraignant. La société se réserve le droite d'apporter des modifications aux produits et accesories en tout le temps.

AZIENDA CON SISTEMA DI GESTIONE QUALITÀ CERTIFICATO. ISO 9001:2015
COMPANY WITH QUALITY MANAGEMENT SYSTEM CERTIFIED TO ISO 9001:2015
ENTREPRISE AVEC UN SYSTÈME DE GESTION DE LA QUALITÉ CERTIFIÉ ISO 9001:2015

Mina s.r.l.
Via Zignone 26
13017 Quaronara (VC) Italy
Tel. +39 0163 432410 / 432756
www.minainox.com

BATHROOM MINA #inox

v.1/B

Art Direction e Styling: Zu.Ba.Lu.

Photography : Neroluca

Graphic: Zu.Ba.Lu.

THANKS TO

Brera Group - Ceramica Flaminia - GSI - Maidea - Moab80 -
Wilson & Morris - Officina Cosmetica Antichi Ricordi - Contro
Occorrente - BigMat Guglielmina | Varallo - Colorificio Villa |
Borgosesia - Novarredo | Boca - Capanne Suites | Montalcino -
Stéphane Herrgott Architecte | Himalayanbirchhouse.ch

A large, white, serif letter 'B' is positioned on the left side of a light blue vertical bar that runs down the center of the page. The 'B' is partially cut off by the left edge of the page.

www.minainox.com

mina

Mina s.r.l.

Via Zignone 26

13017 Quarona (VC) Italy

Tel. +39 0163 432410 / 432756